

Specifications:

Sound level Category	Medium Sound Level
Mode of Operation	Fast Pulse
Mounting	Panel (see note B)
Voltage Rating	30 to 120 Vac/dc
Frequency	4500 Hz ±500 Hz
Loudness (Min. Voltage)	68 dB(A) min. @ 2 FT and 30 Vac/dc
Loudness (Max Voltage)	80 dB(A) min. @ 2FT and 120 Vac/dc
Current Draw	6 mA Max @ 30 Vac/dc
Current Draw	20 mA Max @ 120 Vac/dc
Min. Pulse Rate (PPS)	2 @ 30 Vac/dc
Max. Pulse Rate (PPS)	10 @ 120 Vac/dc
Duty Cycle (%)	50 (Approx)
Storage Temperature	-40°C to +85°C
Operating Temperature	-30°C to +65°C
Weight (Typical)	2.1 oz (60 g)
Housing	6/6 Nylon, Color Black
Options	For other options contact factory

Dimensions: Inches (mm)

PART DIMENSIONS BEFORE CODE DATE 0818 5

PART DIMENSIONS AFTER CODE DATE 0819 1

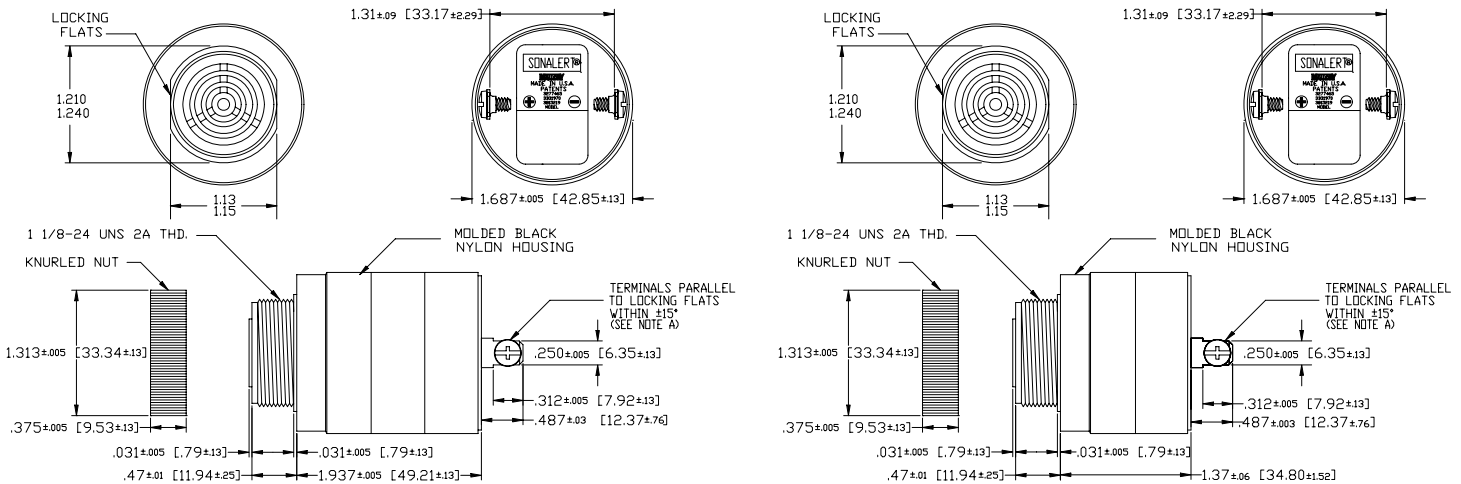

NOTE A: TERMINALS--032 BRASS TIN PLATED, TAPPED FOR #6-32 SCREW. TWO #6-32 NICKEL PLATED BRASS SCREWS INCLUDED. WILL ACCEPT 1/4" QUICK CONNECT.

NOTE B: MOUNTING-- REMOVE BLACK PLASTIC NUT AND INSERT THREADED FRONT THROUGH 125° HOLE PUNCHED IN PANEL. IF ORIENTATION IS NEEDED, NOTE LOCKING FLATS ON DRAWING. SCREW NUT BACK ON. DO NOT OVERTIGHTEN.

NOTE A: TERMINALS--032 BRASS TIN PLATED, TAPPED FOR #6-32 SCREW. TWO #6-32 NICKEL PLATED BRASS SCREWS INCLUDED. WILL ACCEPT 1/4" QUICK CONNECT.

NOTE B: MOUNTING-- REMOVE BLACK PLASTIC NUT AND INSERT THREADED FRONT THROUGH 125° HOLE PUNCHED IN PANEL. IF ORIENTATION IS NEEDED, NOTE LOCKING FLATS ON DRAWING. SCREW NUT BACK ON. DO NOT OVERTIGHTEN.